

smart
architectural aluminium

MC Curtain Wall Series

Smart's versatile MC curtain wall systems offer an extensive range of solutions for the architectural building envelope. The range features options for low and high rise buildings, sloped, faceted or structural glazed facades. All ranges can incorporate Smart's window and door systems..

- Ground floor or multi-storey
- Options for sloped or faceted facades
- Structural glazing
- Incorporates extensive range of windows and doors
- 60 minute fire & heat radiation rated profiles
- CWCT certified

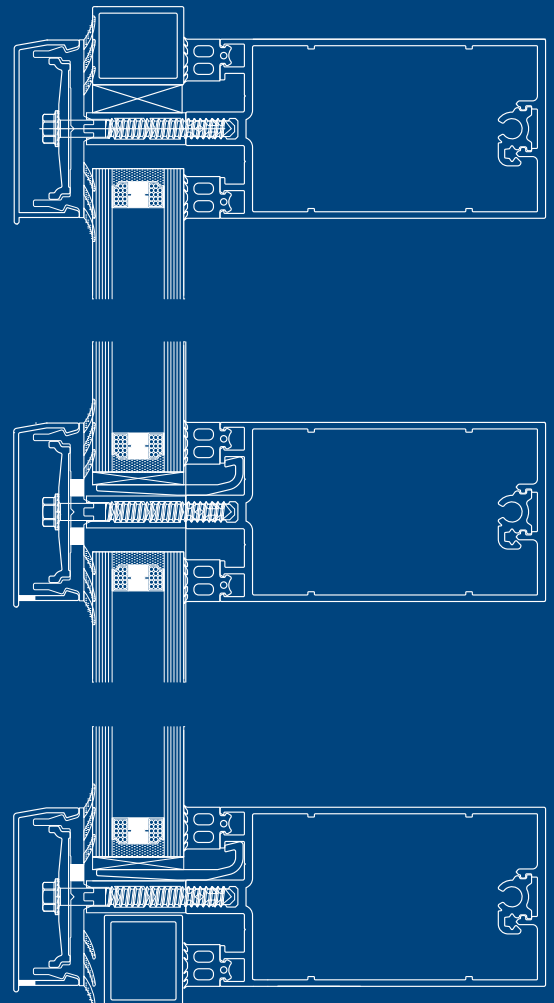

MC 600

Design Features

MC 600 is a new curtain wall system capable of providing impressive, practical & economic glazed façades as a solution for both small and large scale multi-storey commercial buildings and ground floor treatment. The system has been designed with efficient fabrication in mind.

MC 600 benefits from an inter-changeable transom/mullion profile that allows fabricators to utilise the same section for both purposes, whilst achieving consistent sight lines. Depending on requirements MC600 can either be assembled on-site as a stick built system, or alternatively part assembled in the factory. MC600 can incorporate Smart window and door inserts.

System Features

Frame Width	55mm
Dual Colour	Yes
Glass	24mm to 42mm





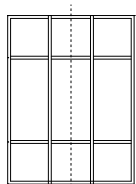
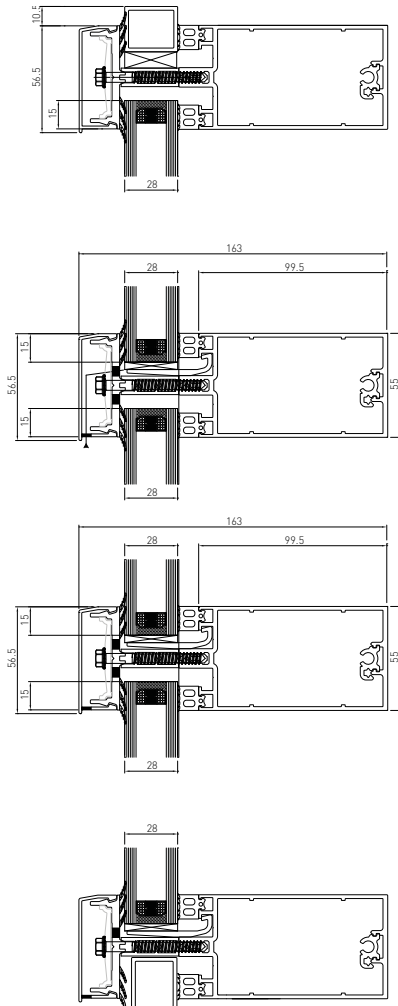

Technical Specification

U Value	From 1.1W/m ² K with 1.0 glass unit or 0.85W/m ² K with 0.7 glass unit
Doc L Compliant	Yes
Air	600Pa
Water	600Pa
Wind	2400Pa
CWCT Certified	Yes

Insert Configuration

Top Hung	Yes
Side Hung	Yes
Bottom Hung	Yes
Fixed	Yes
Tilt & Turn	Yes
Parallel Opening	Yes
Reversible	Yes
Single Door	Yes
Double Door	Yes
Sliding Door	Yes
Sliding Folding Door	Yes



 U Value 1.1W/m ² K	 Air 600Pa
 Document L	 Water 600Pa
 WINDOW CLADDING CERTIFIED	 Wind 2400Pa



MC Wall

Design Features

MC Wall is a system that designed to create a dramatic but practical façades that allow maximum light into small or large multi-storey buildings. The range offers a wide range of options including sloped and facet-shaped glazing, screens and doors.

Rapid on-site installation and concealed transoms, for seamless/uninterrupted glass to glass joints, are among the many special features of this versatile polyamide thermal break system it shares with MC600. The system incorporates a top hung frameless vent and can also accommodate Smart's windows and door systems.

System Features

Frame Width	55mm
Dual Colour	Yes
Glass	24mm to 34mm (for units over 34mm please contact technical team)





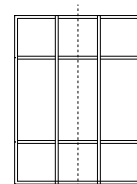

Technical Specification

U Value	From 1.1W/m ² K with 1.0 glass unit or 0.85W/m ² K with 0.7 glass unit
Doc L Compliant	Yes
Air	600Pa
Water	600Pa
Wind	2400Pa
CWCT Certified	Yes

Insert Configuration

Top Hung	Yes
Side Hung	Yes
Bottom Hung	Yes
Fixed	Yes
Tilt & Turn	Yes
Parallel Opening	Yes
Reversible	Yes
Single Door	Yes
Double Door	Yes
Sliding Door	Yes
Sliding Folding Door	Yes



 U Value 1.1W/m ² K	 Air 600Pa
 Document L	 Water 600Pa
 WINDOW CLADDING CERTIFIED	 Wind 2400Pa

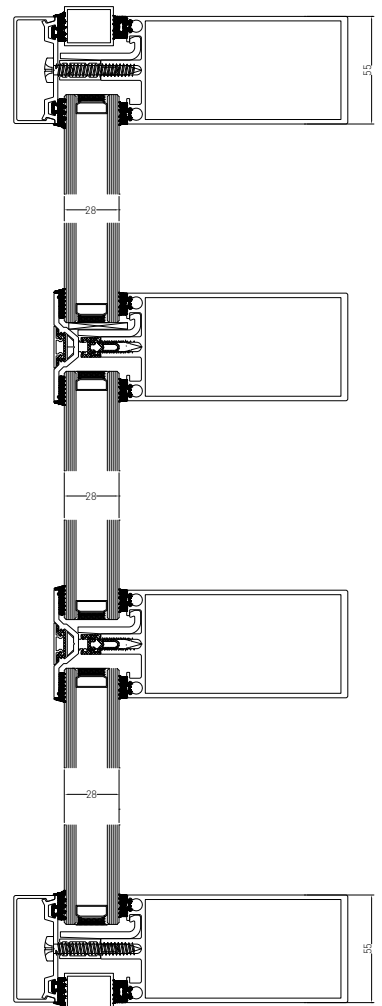

MC Glass

Design Features

MC Glass is an innovative structural glazing solution that offers a completely flush glass façade with the requirement for external glass capping. Suitable for low or high rise structures, MC Glass can be fitted with frameless vents that are not visible from the inside or outside of the building.

System Features

Frame Width	55mm (internal)
Dual Colour	Only single colour internally
Glass	28mm (for units over 34mm please contact technical team)

Technical Specification

U Value	From 1.1W/m ² K with 1.0 glass unit or 0.85W/m ² K with 0.7 glass unit
Doc L Compliant	Yes
Air	Class AE 1300Pa
Water	Class AE 1800Pa
Wind	2000Pa

Insert Configuration

Top Hung	Yes
Side Hung	Yes
Bottom Hung	Yes
Fixed	Yes
Tilt & Turn	Yes
Parallel Opening	Yes
Reversible	Yes
Single Door	Yes
Double Door	Yes
Sliding Door	Yes
Sliding Folding Door	Yes

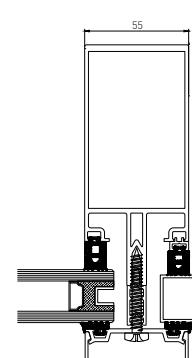
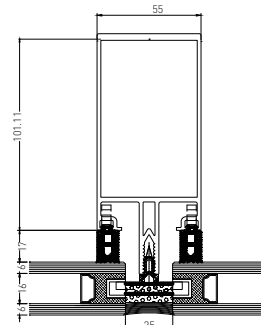
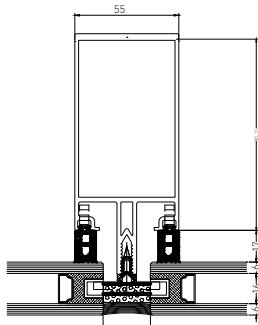
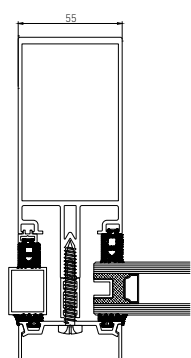
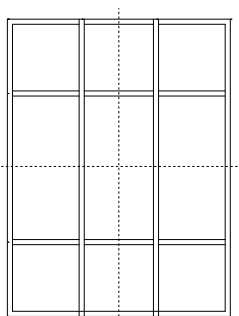
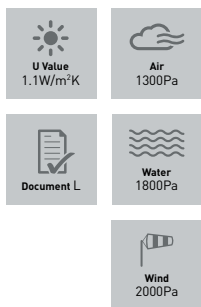
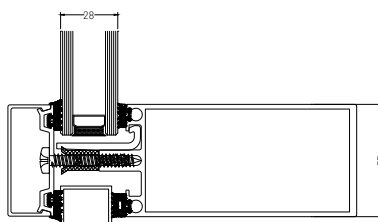
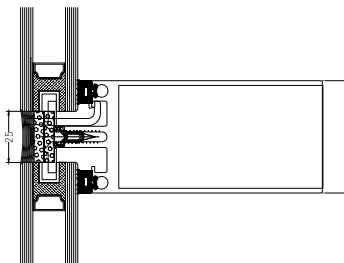
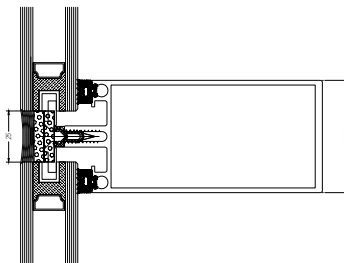
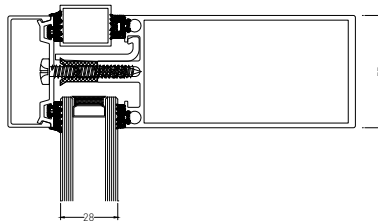

MC Fire

Design Features

MC Fire is a new range of fire and heat radiation resistant profiles compliant with European standards to a 60 minute rating. The system includes fire resistant curtain wall and entrance door profiles based on the design of Smart's MC Wall curtain wall products.

MC Fire has been designed to prevent a fire from spreading and provide a safe evacuation route time frame of 60 minutes. The fire resistant frame is achieved by inserting special fire resistant material into the internal profile chambers. This material acts as reinforcing for the aluminium, as the profiles heat up the fire resistant inserts along with steel components prevent the frames from buckling.

System Features

Frame Width	55mm
Dual Colour	Yes
Glass	15mm to 48mm EI60 glass units

Technical Specification

U Value	From 1.1W/m ² K with 1.0 glass unit or 0.85W/m ² K with 0.7 glass unit
Doc L Compliant	Yes
Air	Class AE1300 1300Pa
Water	Class RE1500 1500Pa
Wind	2600Pa
Fire Resistance Certification	EI60
European Testing Standard	EN 1634-1:2008

Insert Configuration

Top Hung	No
Side Hung	No
Bottom Hung	No
Fixed	No
Tilt & Turn	No
Parallel Opening	No
Reversible	No
Single Door	Yes
Double Door	Yes
Sliding Door	No
Sliding Folding Door	No

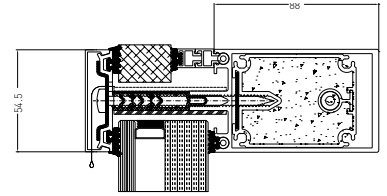
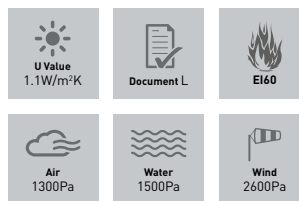
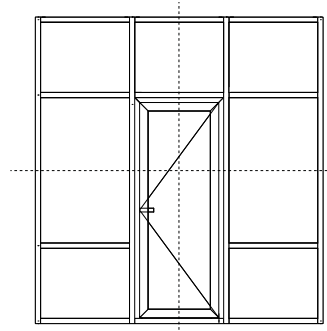

Shown Double Glazed

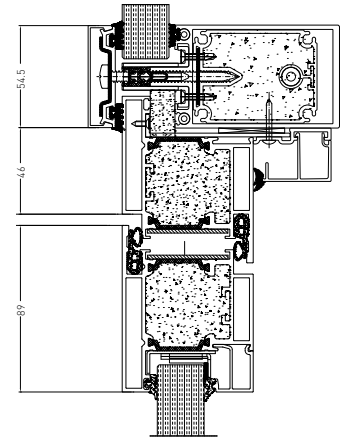

Shown Single Glazed

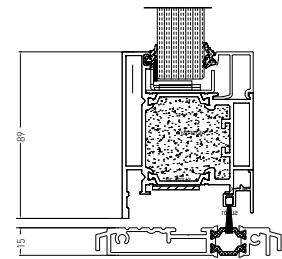

Shown Double Glazed

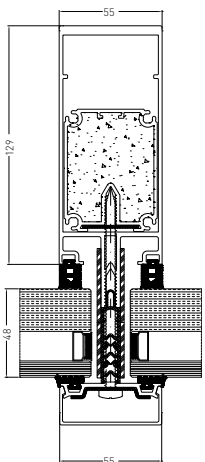

Shown Double Glazed

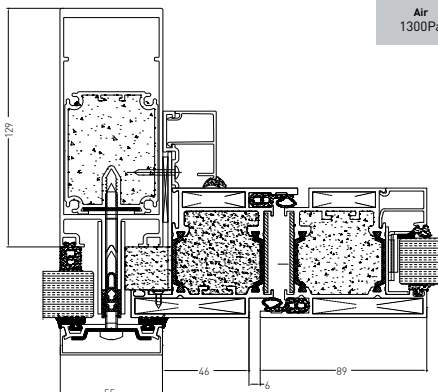

Shown Single Glazed

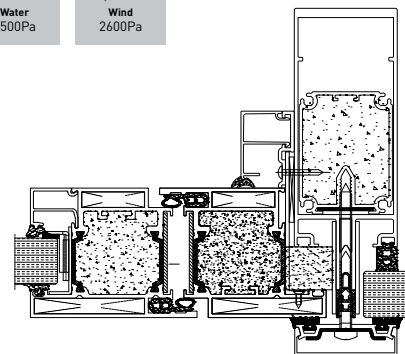

Shown Single Glazed

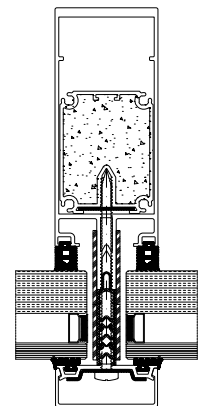

Shown Double Glazed

Smart Systems Limited

Arnolds Way | Yatton | Bristol | North Somerset | BS49 4QN | UK

T +44 (0) 1934 876 100 | F +44 (0) 1934 835 169 |

W www.smartsystems.co.uk | E sales@smartsystems.co.uk

IMS300CWS.201602

The images, drawings and data shown in this brochure are for illustrative purposes only and are not binding in detail, colour or specification. We reserve the right to make changes to the product specification as technical developments dictate and without prior notice. We recommend that the user ensures that they are satisfied the product meets their requirements prior to purchase. ©Smart Systems Ltd 2016